

National Energy Code of Canada for Buildings (NECB)

Presented at: Manitoba Energy Code for Buildings (MECB) Training Day

September 17, 2014

Heather Knudsen, P. Eng.

NRC Construction

Canadian Codes Centre



Outline

- Canada's Code Development System
- Objective-based codes
- History of energy code development in Canada
- NECB 2011:
 - approach
 - application
 - compliance paths
 - performance level
 - supporting documents and tools
- NECB 2011 Part 7: Electrical Power Systems and Motors

Terminology

- MNECB: 1997 Model National Energy Code for Buildings
- NECB: 2011 National Energy Code for Buildings
- SCEEB: Standing Committee on Energy Efficiency in Buildings
- CCBFC/Commission: Canadian Commission on Building and Fire Codes
- PTPACC: Provincial/Territorial Policy Advisory Committee on Codes

Canada's Code Development System

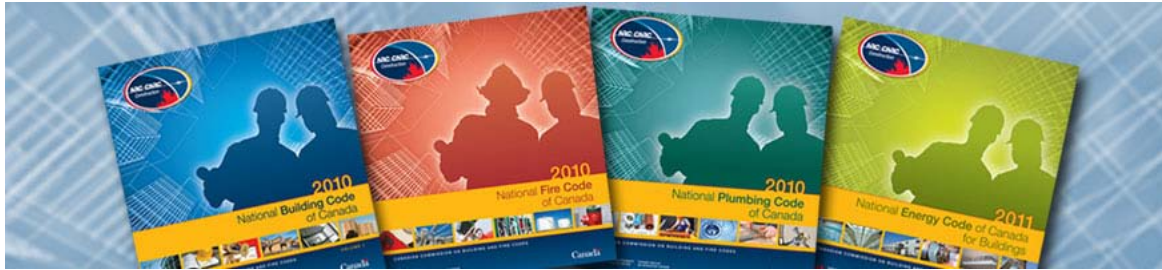

- National Building Code
- National Fire Code
- National Plumbing Code
- National Energy Code for Buildings

Canada's Code Development System

- National model construction codes must be adopted by provincial or territorial authorities to become law
- Manitoba adopted NECB with amendments on December 20, 2013, with enforcement to begin December 1, 2014

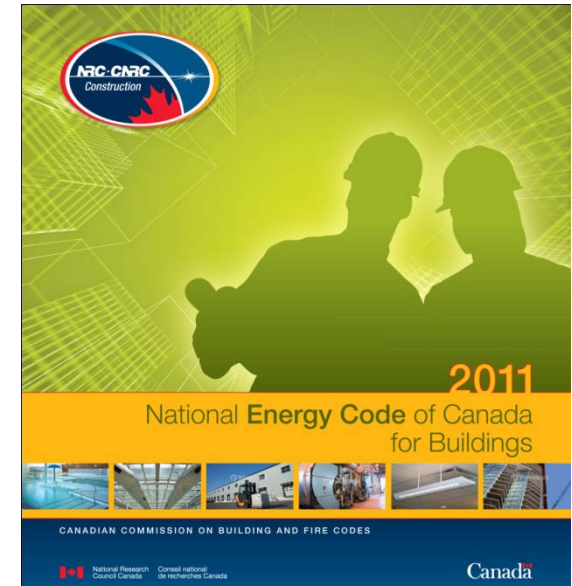

Canada's Code Development System

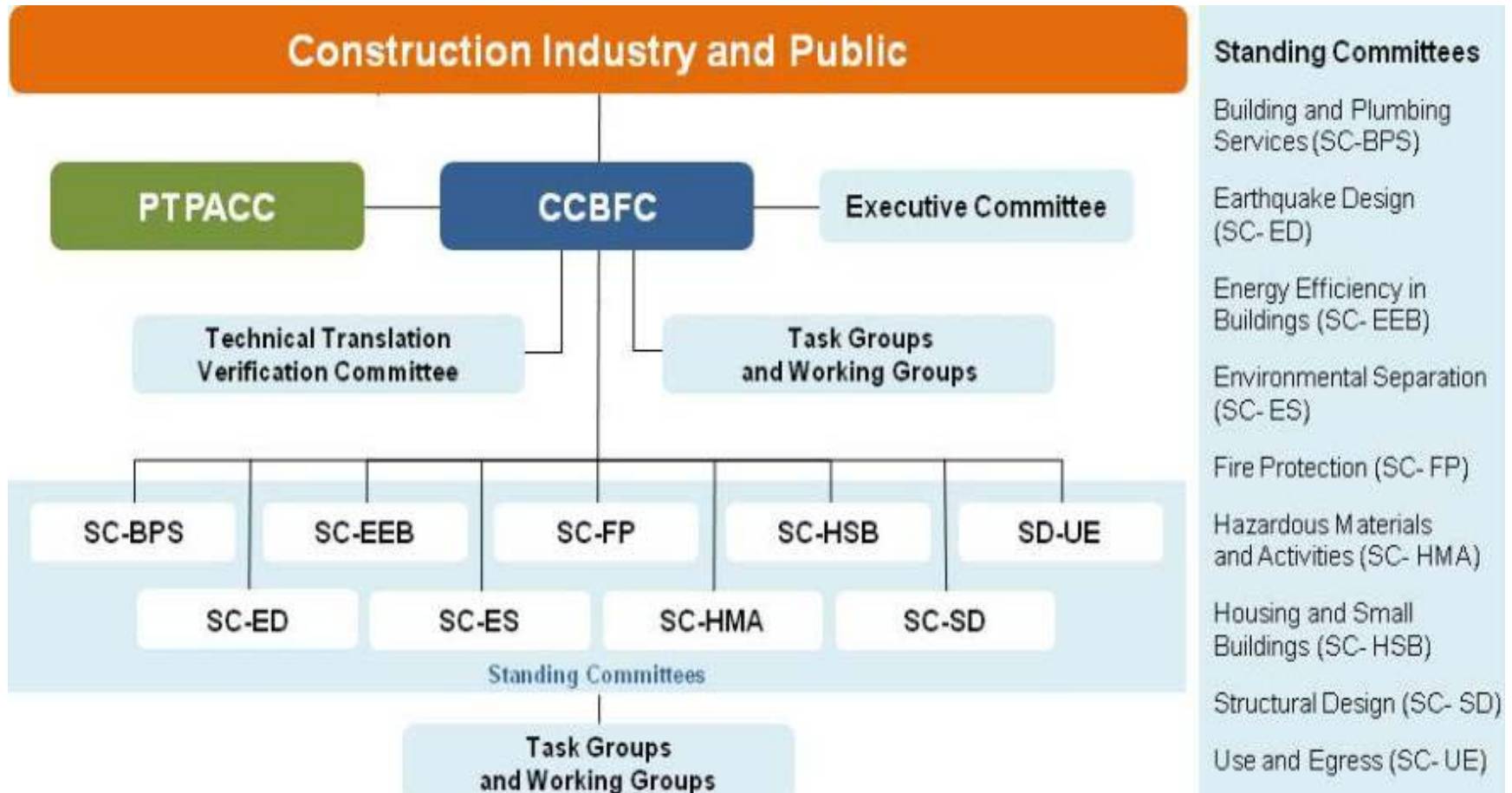

Canada's Code Development System

The CCBFC:

- promotes uniform adoption and understanding of the National Model Construction Code Documents
- responds to the needs and priorities of the adopting authorities
- facilitates the resolution of issues related to the code documents
- establishes and implements policies, procedures and priorities and
- advises NRC on the need for code-related research

Canada's Code Development System

Membership of the CCBFC and its Standing Committees reflects a matrix with:

- balanced representation from major sectors
 - regulatory
 - industry
 - general interest
- broad geographic representation

Canada's Code Development System

From code change request to proposed change:

- Code change request from proponent
- CCC staff analysis
- Standing Committee review
- CCBFC input
- Standing Committee development
- Proposed Change (PCF)

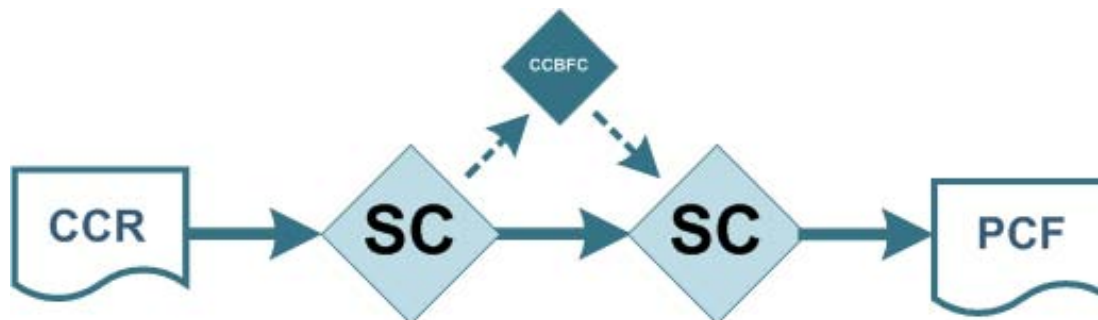

Canada's Code Development System

From proposed change (PCF) to requirement:

- Public review
- Standing committee final recommendation
- Commission decision
- Publication of codes

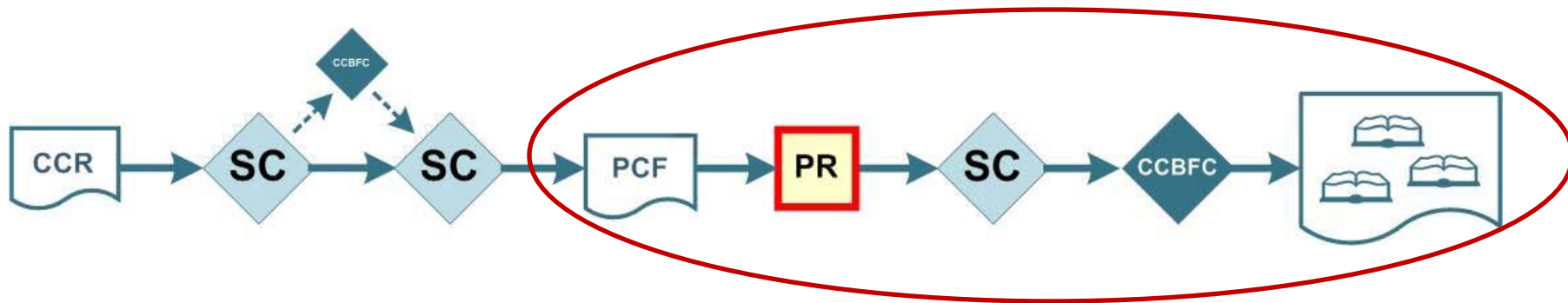

Canada's Code Development System

Code Change Request

- anyone can request a code change
- SC reviews and decides to address or reject a request
- only minor tasks can be addressed without approval
- more complex issues are subject to approval by CCBFC
- major scope, cost or policy implications go to CCBFC

Proposed Change

- cost-benefit and enforcement implications are important
- there are rules for code requirements
- SCs address all public comments
- Final approval rests with the CCBFC

NRC Construction Role

- Administrative and technical advisory support to CCBFC and PTPACC (Canadian Codes Centre)
- Research support to the development of national model codes (e.g. hygrothermal performance of buildings)
- Construction materials evaluation service for industry and regulatory authorities (Canadian Construction Materials Centre)

Outline

- Canada's Code Development System
- **Objective-based codes**
- History of energy code development in Canada
- NECB 2011:
 - approach,
 - application,
 - compliance paths,
 - performance level,
 - supporting documents and tools
- NECB 2011 Part 7: Electrical Power Systems and Motors

Objective-based Codes

Three Divisions in each model code:

- Division A – Compliance, Objectives and Functional Statements
- Division B – Acceptable Solutions
- Division C – Administrative Provisions

Objective-based Codes

- Spell out why building design and construction is regulated: “**Objectives**” in Division A
- Describe what the design and construction of the building must do to achieve the objectives “**Functional Statements**” in Division A
- Provide “**Acceptable Solutions**” that meet the objectives and functional statements in Division B
- Allow for “**Alternative Solutions**”, provided they meet the same objectives and functional statements

Objective-based codes – NECB Objective

OE Environment

An objective of this Code is to limit the probability that, as a result of the design or construction of the building, the environment will be affected in an unacceptable manner.

OE1 Resources

An objective of this Code is to limit the probability that, as a result of the design or construction of the building, resources will be used in a manner that will have an unacceptable effect on the environment. The risks of unacceptable effect on the environment due to use of resources addressed in this Code are those caused by –

OE1.1 excessive use of energy

Objective-based Codes - Example

Sentence 4.2.1.3.(1) specifies the limits to installed interior lighting power. These limits are considered to be **acceptable solutions** with regards to energy use.

In an attribution table, the Sentence is linked to

- **Functional Statement F94:**
To limit the unnecessary demand and/or consumption of energy for lighting.
- **Objective OE 1.1:**
Environment – Resources – Limiting the probability of excessive use of energy

An **alternative solution** might entail a higher installed interior lighting power than permitted but with provision of additional control of that lighting (beyond existing control requirements).

Objective-based Codes

Supplement to NECB 2011 – Intent Statements

- Intent Statements explain in plain language the reason for a Code provision
- Use standard phrases "to limit the probability that/of..."
..."which could lead to..."
- Published electronically only
- Not code material

Outline

- Canada's Code Development System
- Objective-based codes
- **History of energy code development in Canada**
- **NECB 2011:**
 - approach,
 - application,
 - compliance paths,
 - performance level,
 - supporting documents and tools
- **NECB 2011 Part 7: Electrical Power Systems and Motors**

History of energy codes in Canada

- 1974 – Department of Energy, Mines and Resources requested interdepartmental committee to draft guidelines for energy efficiency of government buildings
- Associate Committee on National Building Code (ACNBC) given mandate

History of energy codes in Canada

- Standing Committee on Energy Conservation in Buildings
 - First meeting – November 1976
 - Code set as prescriptive
 - Code based on ASHRAE 90.1 Standard
- Fall 1977 – first draft document for public comment

History of energy codes in Canada

- 1978 – First edition of “Measures for Energy Conservation in New Buildings”

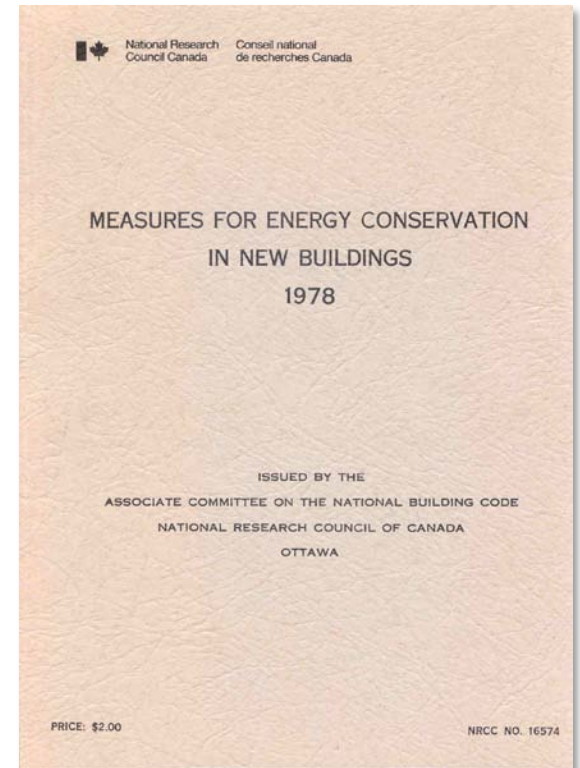

History of energy codes in Canada

- Second edition of “Measures for Energy Conservation in Buildings” published in 1983
 - New section for houses
 - Quebec only province to adopt Measures, with some changes
 - 1990 Ontario Building Code included insulation levels for houses based on 1983 edition
 - CMHC – compliance mandatory for housing financed under National Housing Act

History of energy codes in Canada

Model National Energy Code for Buildings 1997

- Prescriptive approach: building envelope, HVAC, service water heating, lighting, electrical power
- Engineering approach: “Performance Compliance for Buildings”

Model National Energy Code for Houses (MNECH) also published in 1997



History of energy codes in Canada

Model National Energy Code for Buildings 1997

- Referenced in Ontario Building Code
- Used in voluntary and incentive programs
 - Commercial Buildings Incentive Program
 - Utility and other programs
 - LEED®



History of energy codes in Canada

Model National Energy Code for Buildings 1997

- Energy/economics code
- Requirements and exemptions based on
 - Principal energy source
 - “Administrative region”
 - Climatic criteria
 - Energy distributor

History of energy codes in Canada

Model National Energy Code for Buildings 1997

- No consistent performance level established through the different compliance paths
 - Prescriptive path and simple building envelope trade-off path
 - Performance varied with fenestration-to-wall ratio
 - Computer-assisted building envelope trade-off path and performance compliance path
 - Performance varied with fenestration-to-wall ratio to 40%, capped at 40% for fenestration to wall ratios above 40%

History of energy codes in Canada

- NRCan presentation and request to update MNECB 1997 at June 2005 CCBFC meeting
- Motion
 - “Moved ... and seconded ... that CCBFC supports, as a first phase, the work on the technical basis for the development of the revisions to the MNECB as a progeny document on condition that the necessary support and funding for the project is provided from NRCan and/or others.”

History of energy codes in Canada

- Building Energy Codes Collaborative (BECC)
 - Business plan
 - Provincial / territorial support
 - Funding from NRCan
- Plan to update MNECB 1997 presented and approved at February 2007 CCBFC meeting

History of energy codes in Canada

- Standing Committee on Energy Efficiency in Buildings (SCEEB) formed in 2007
- First meeting in December 2007



Outline

- Canada's Code Development System
- Objective-based codes
- History of energy code development in Canada
- **NECB 2011:**
 - approach,
 - application,
 - compliance paths,
 - performance level,
 - supporting documents and tools
- NECB 2011 Part 7: Electrical Power Systems and Motors

NECB approach

- Energy used by building
→ energy source neutral
- Based on climatic
zone – heating
degree-days
(HDD)

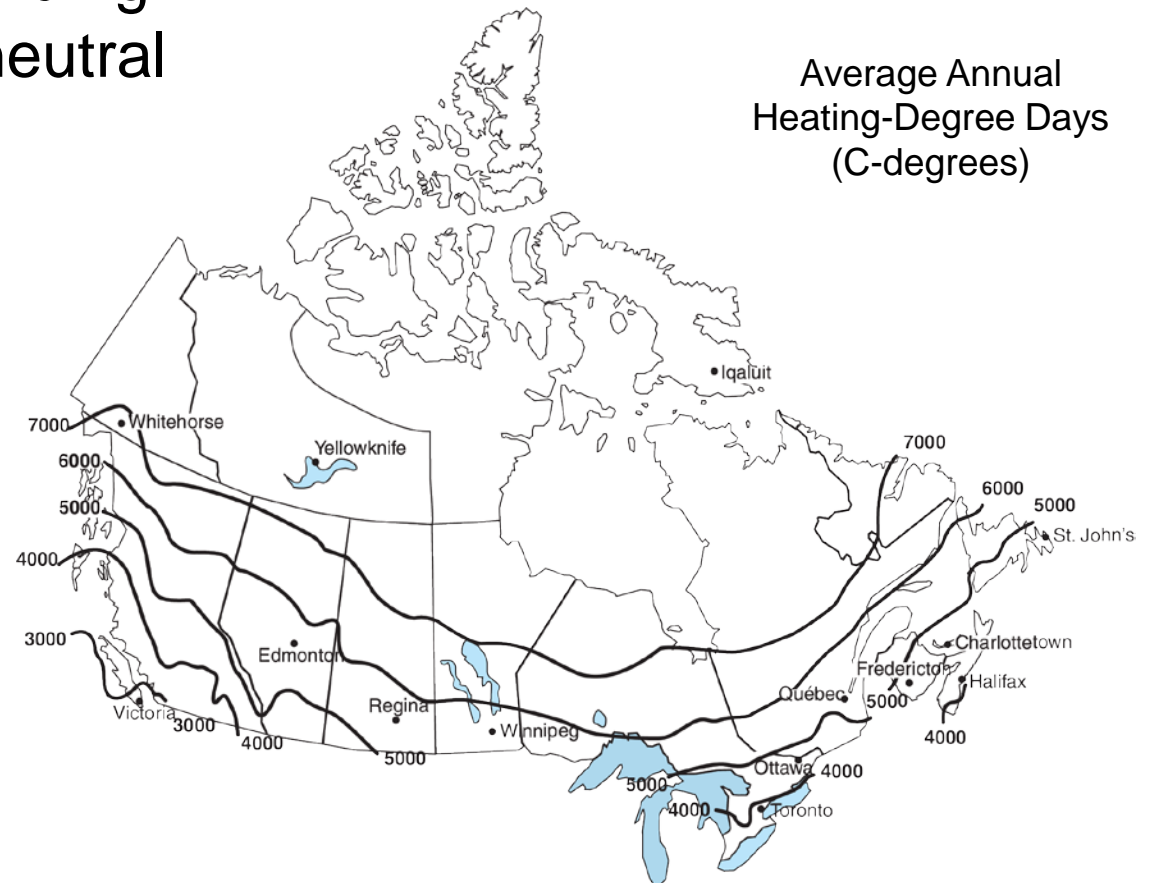

NECB approach

- Silent on renewable, waste and site-generated energy
 - Wide variety of technology
 - Not place barriers for their use
 - Reference standards for use, not efficiency



NECB approach

- Silent on most process loads
 - Except pools and ice surfaces
 - Performance path includes:
 - Guidance
 - Flexibility



NECB approach

- No differentiation based on occupancy
- Same structure as MNECB
 - Part 3: Building Envelope
 - Part 4: Lighting
 - Part 5: Heating, Ventilating and Air-Conditioning Systems
 - Part 6: Service Water Heating Systems
 - Part 7: Electrical Power Systems and Motors
 - Part 8: Performance Path

NECB application

- New buildings (as defined in NBC; “Part 3 buildings”)
- Additions
- Does not apply to major renovations, farm buildings



NECB compliance paths

- Prescriptive path
- Building envelope trade-off paths
 - Simple
 - Detailed
- Lighting, HVAC and service water trade-off paths
- Performance compliance path
 - Whole-building modeling / engineering solution

NECB compliance paths

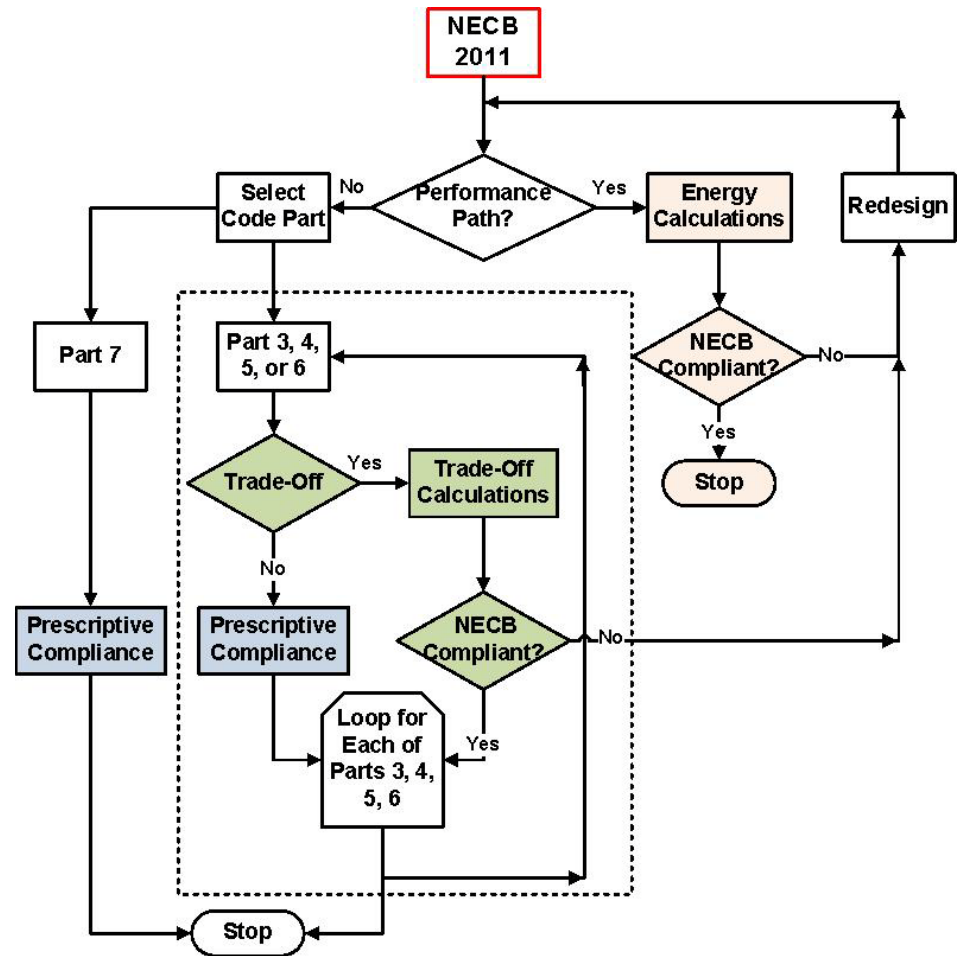

NECB compliance paths

- Mix and match simple prescriptive and trade-off paths
- Use trade-off within same Part only

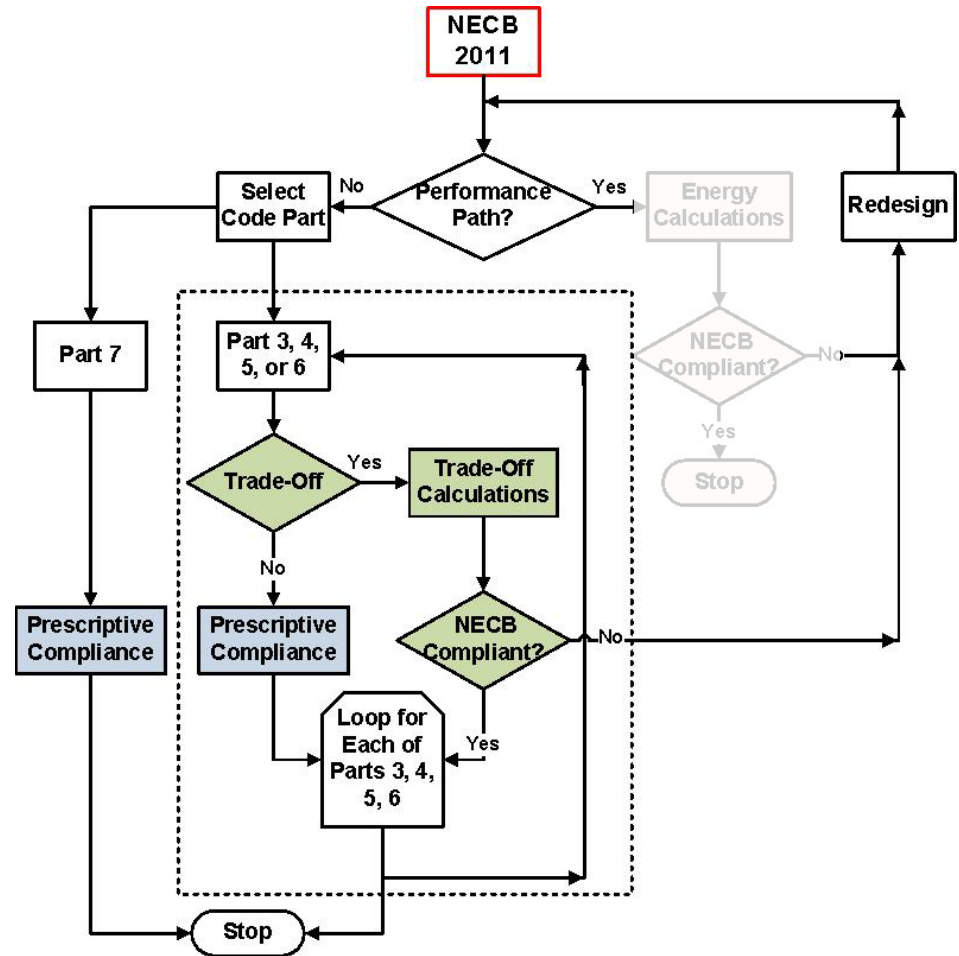

NECB compliance paths

- Cannot mix any other path with performance compliance path (whole building approach)

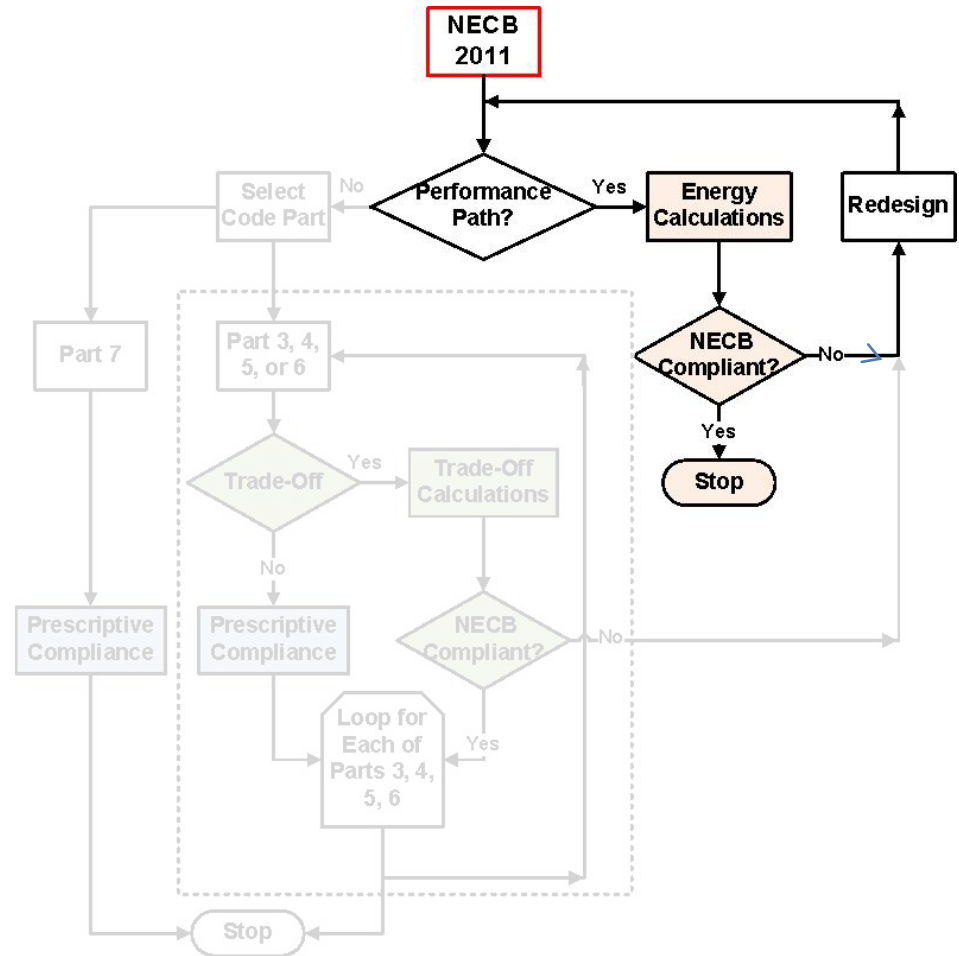

NECB performance level

- Consistent minimum acceptable performance level for all compliance paths
- Established based on minimum prescriptive path requirements

NECB vs MNECB performance levels

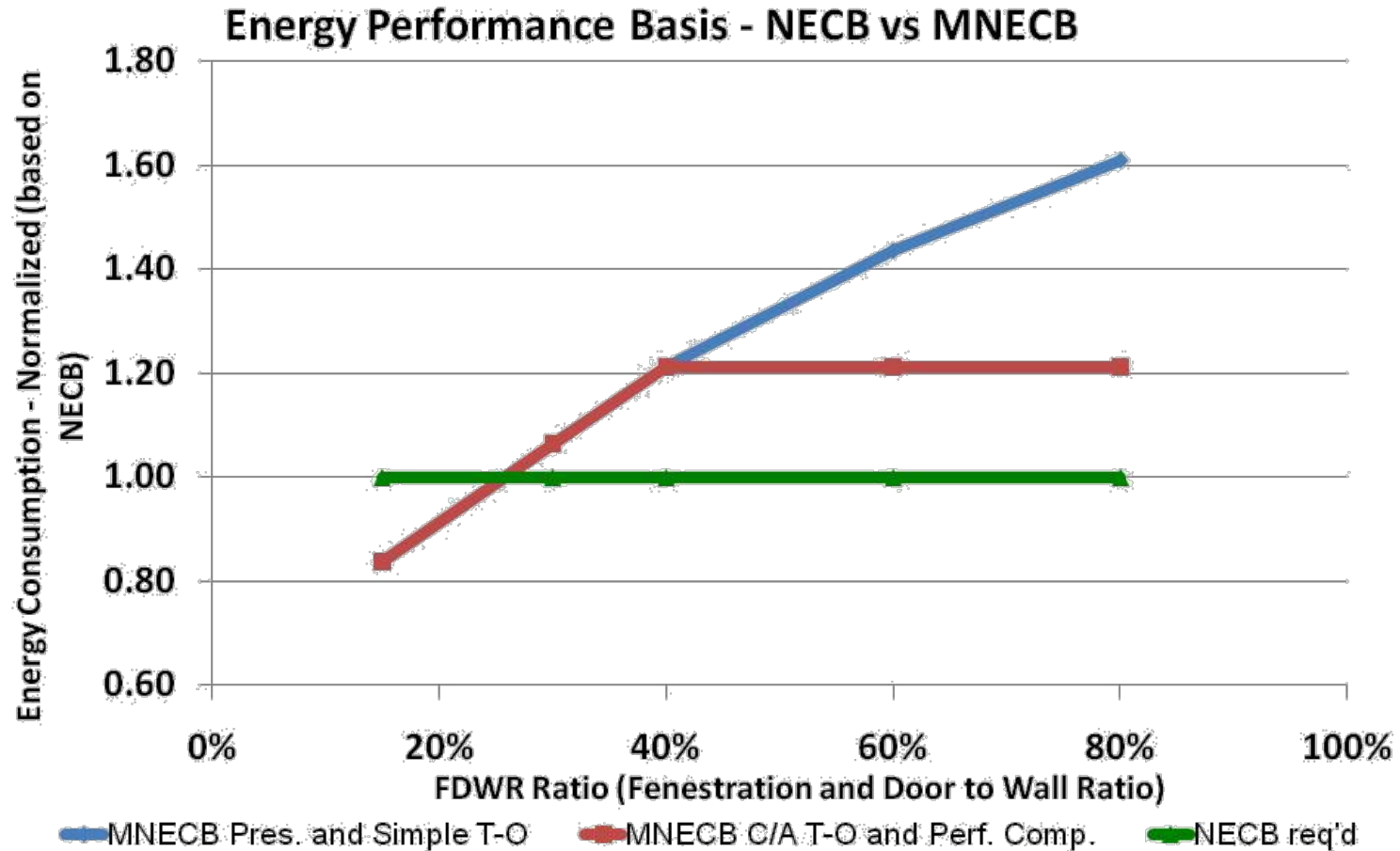

NECB performance results

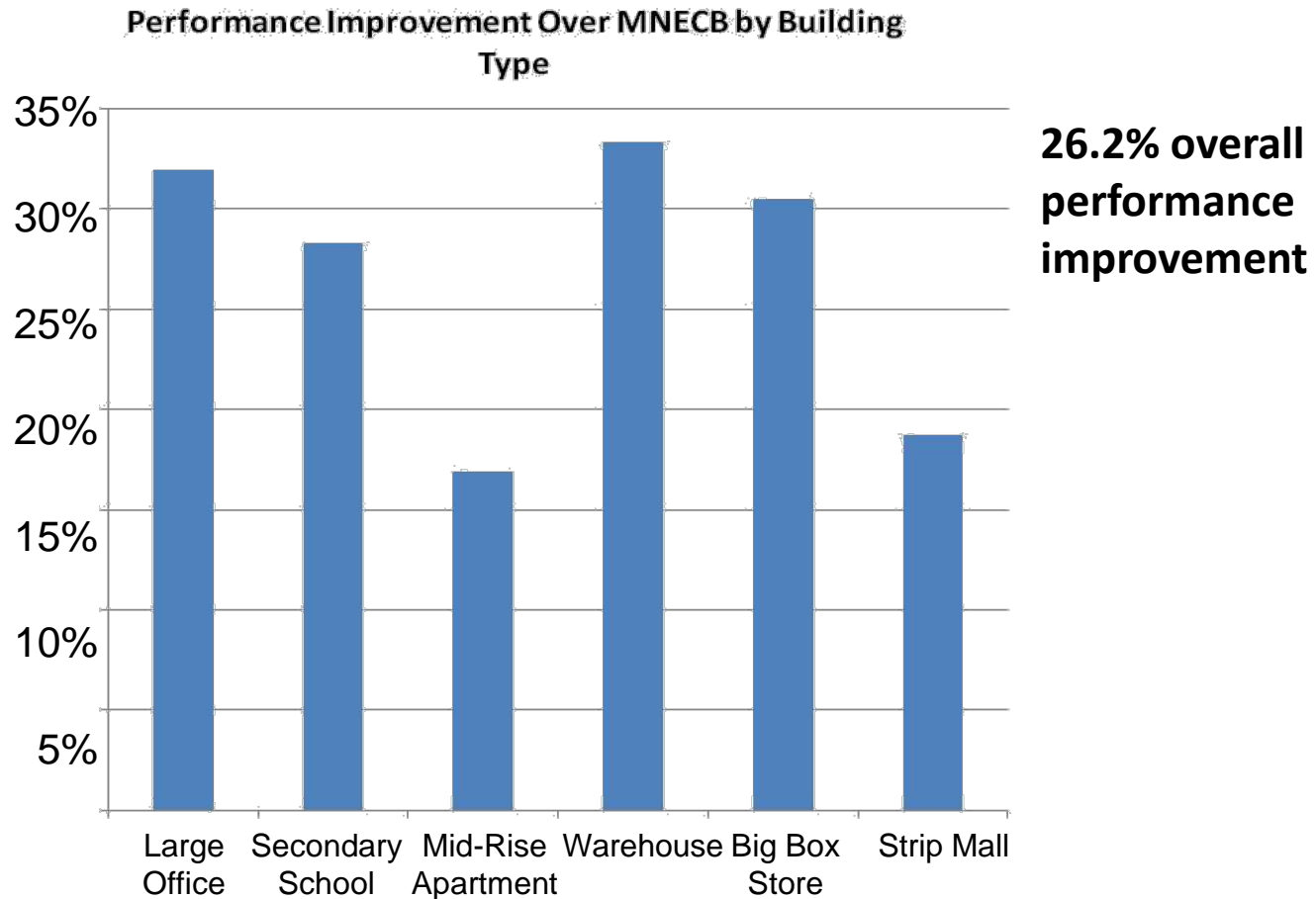

NECB performance results

Performance Improvement over MNECB by City

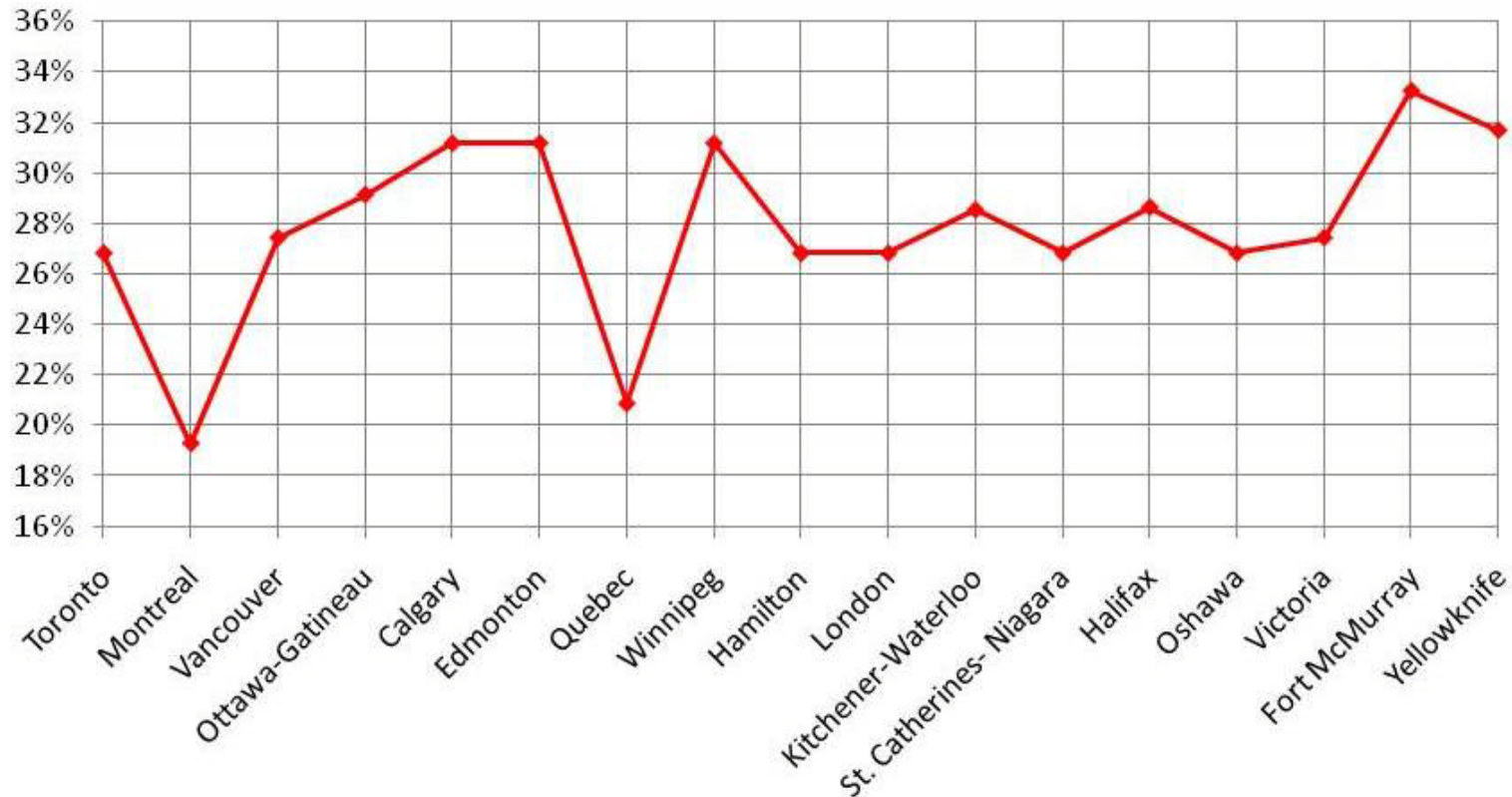

NECB 2011 supporting documents and tools

- Supplement to the NECB 2011: Intents Statements
- User's Guide to the NECB 2011 *new*
- Trade-off Path Tools *coming soon*
 - Lighting trade-off path
 - HVAC and SWH trade-off paths
- NECB 2011 Compliance Checklists
- Adaptation Guidelines for the NECB 2011
- Online presentations on each Part

- Energy modeling software with NECB 2011 reference building: CAN-QUEST

Outline

- Canada's Code Development System
- Objective-based codes
- History of energy code development in Canada
- NECB 2011:
 - approach,
 - application,
 - compliance paths,
 - performance level,
 - supporting documents and tools
- **NECB 2011 Part 7: Electrical Power Systems and Motors**

NECB 2011 Part 7: Electrical Power Systems and Motors

- Part 7 applies to electrical power systems and motors connected to the building's electrical service

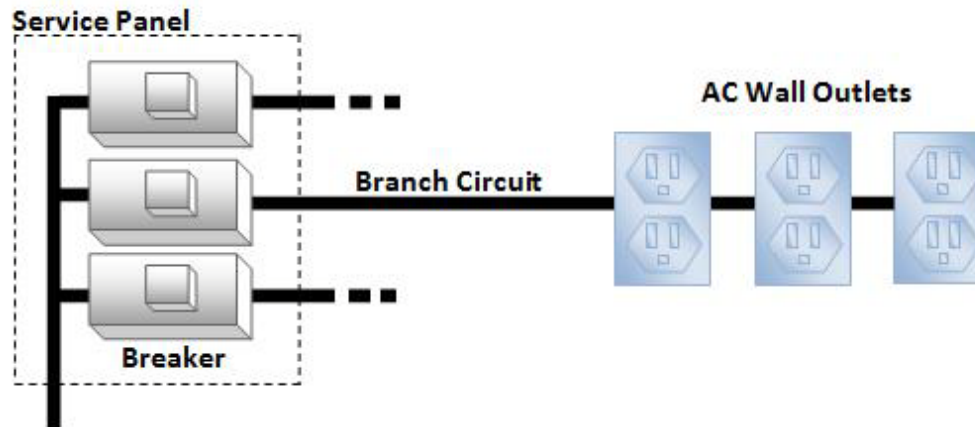

NECB 2011 Part 7: Electrical Power Systems and Motors

- Prescriptive requirements
 - Electrical distribution system
 - Voltage drop - feeder conductors and branch circuits
 - Transformers
 - Electrical motors
- There is no trade-off path in Part 7

NECB 2011 Part 7: Electrical Power Systems and Motors

- Prescriptive requirements
 - Electrical distribution system
 - Voltage drop - feeder conductors and branch circuits
 - Transformers
 - Electrical motors
- There is no trade-off path in Part 7

NECB 2011 Part 7: Electrical Power Systems and Motors

- Prescriptive requirements
 - Electrical distribution system
 - Voltage drop - feeder conductors and branch circuits
 - Transformers
 - Electrical motors
- There is no trade-off path in Part 7

Questions?

www.nationalcodes.nrc.gc.ca

Thank you

